



LEVITATOR 4

EN1176-1:2017
EN1176-11:2014



3+

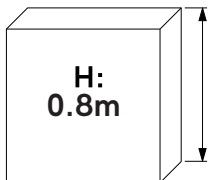
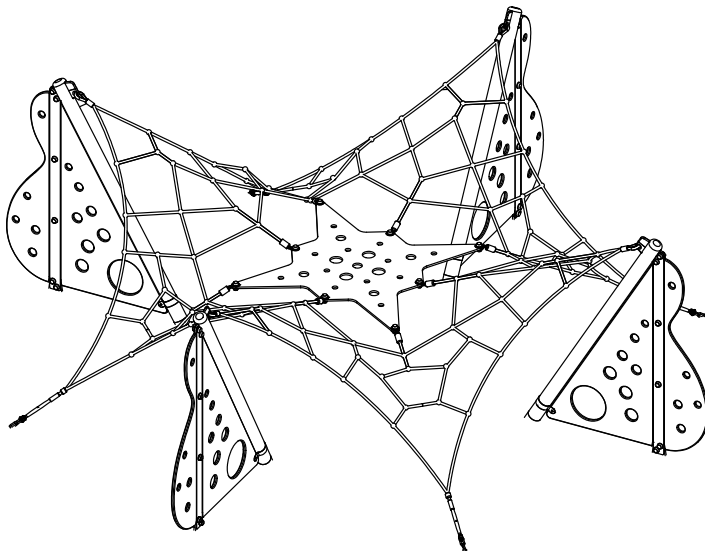

4-5	
6-7	
8-15	
17	

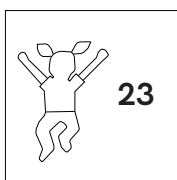
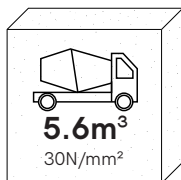

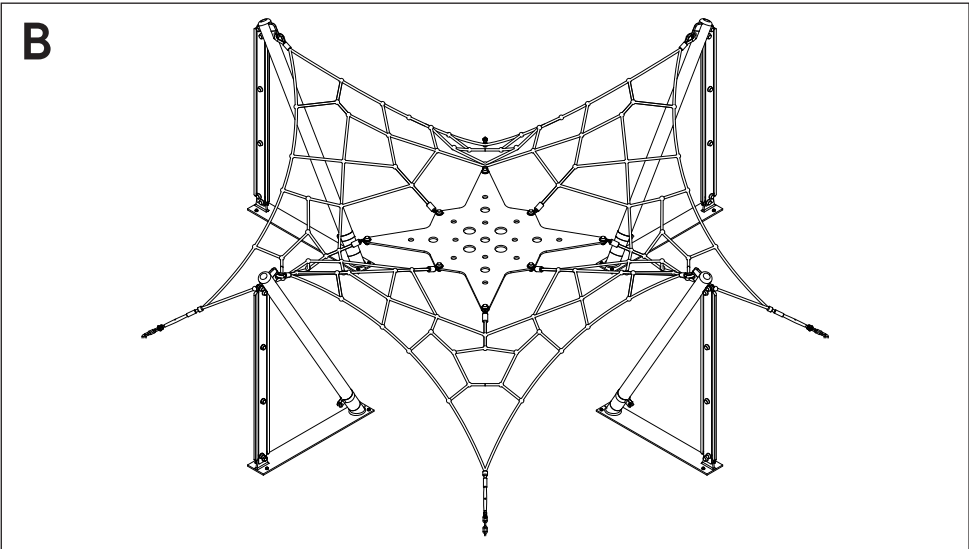
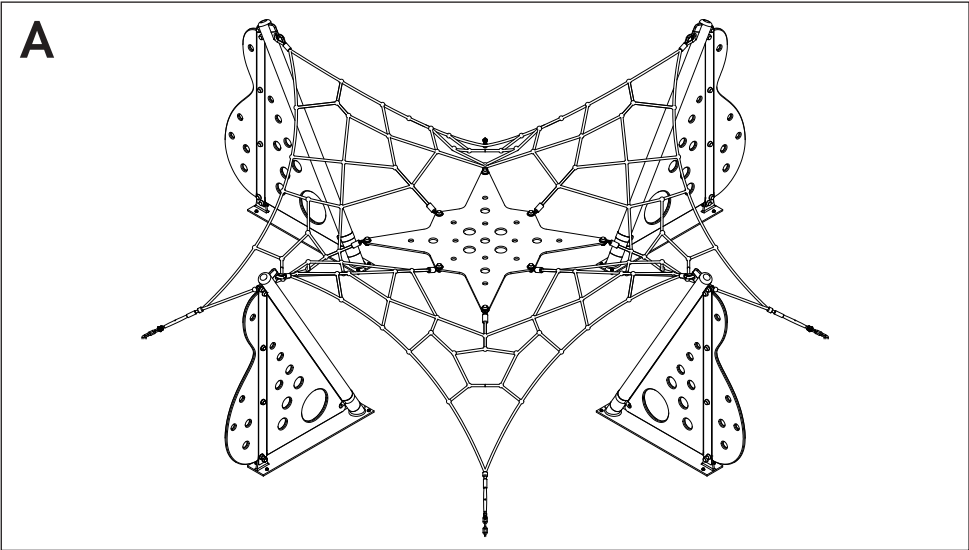

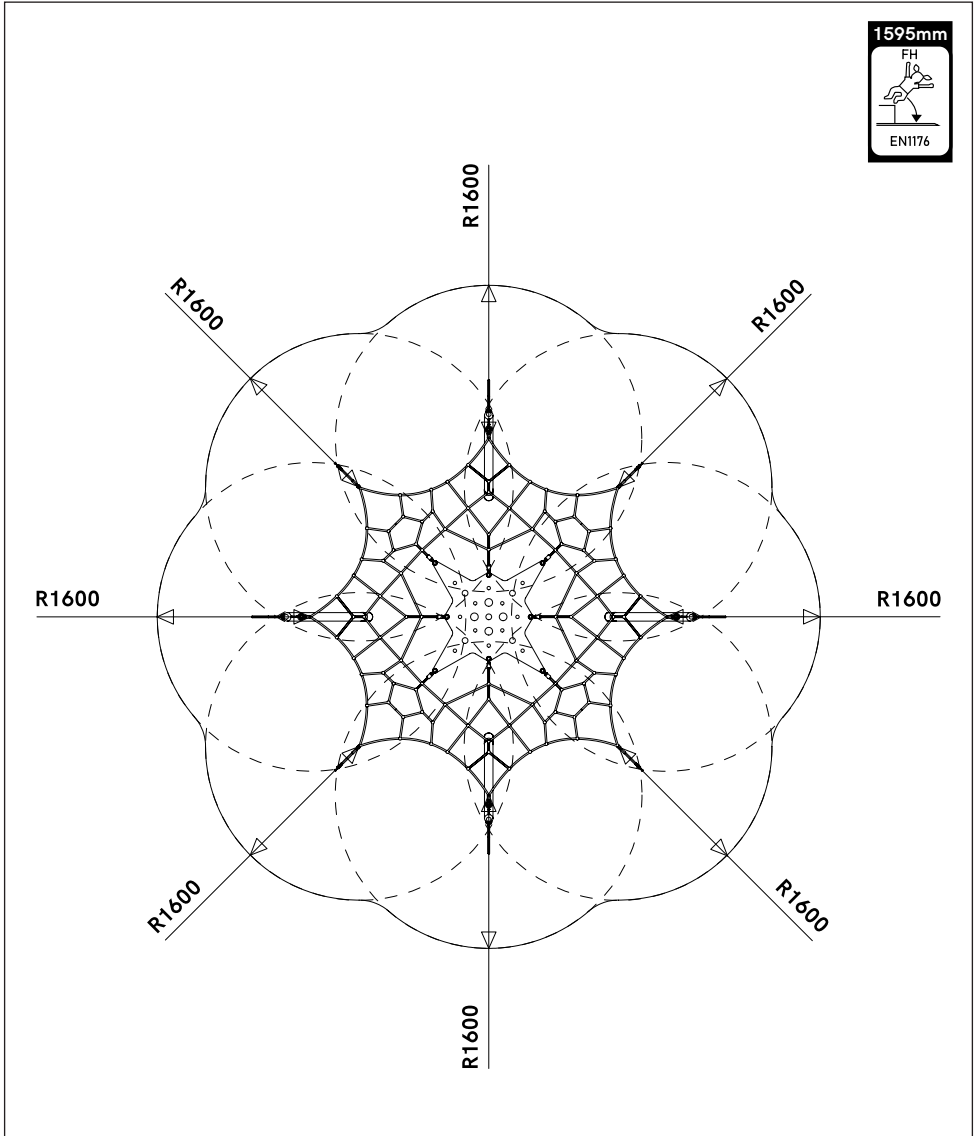



1.1 - LEVITATOR 4 NET w/ KEYS

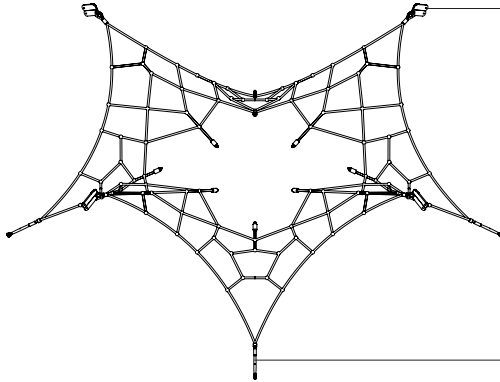

1x

1.2

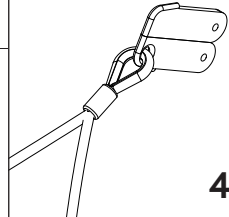

4x

1.3

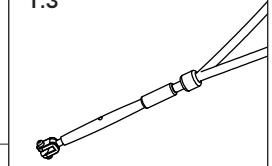

4x

2.1 - REINFORCED RUBBER CENTRE

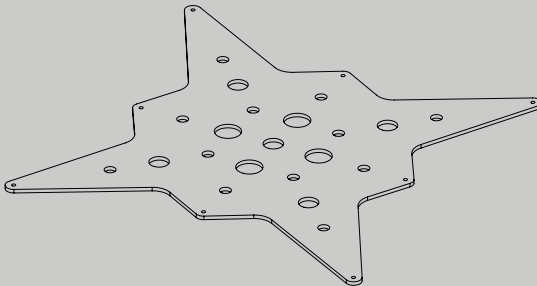

1x

2.2

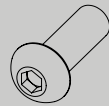

8x

2.3



8x



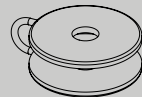













2.4



8x





#				
3.1		x4	LEG FOOT	
3.2		x4	LEG	
3.3		x4	TIE	
4.1		x4	INFILL PANEL	A
4.2		x4	LEG BRACKET	A
5.0		x4	BASIC PANEL	B
6.1		x3	KEY PEG 6x20	
6.2		x28(A) x24(B)	TIE BOLT M12x35	
6.3		x28(A) x24(B)	NUT	
6.4		x72(A) x64(B)	BOLT WASHER	
6.5		x72(A) x64(B)	BOLT COVER	
6.6		x16	HILTI HUS-HR 10x130	
7.1		x4	CHAIN	
7.2		x4	THREADED BAR	
7.3		x8	WASHER FOR BAR	
7.4		x8	NUT FOR BAR	



1

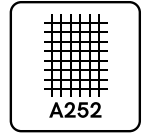
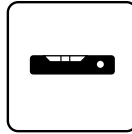
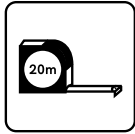

7 x 24h

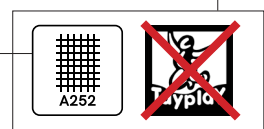
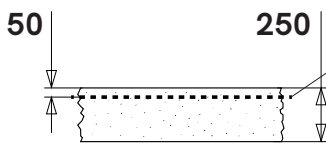
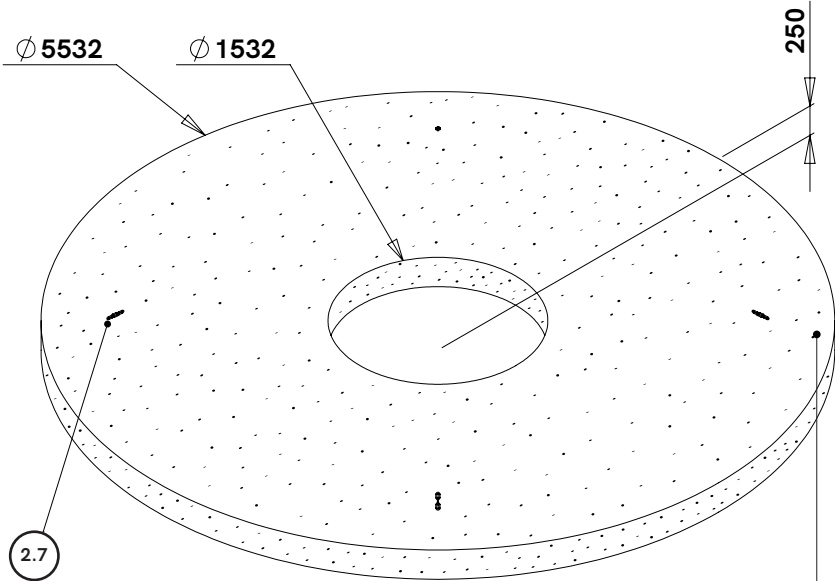
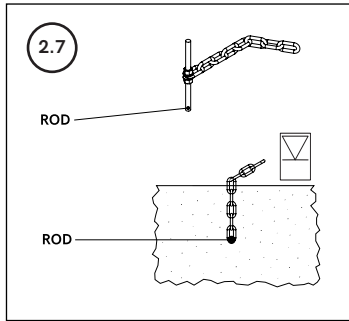

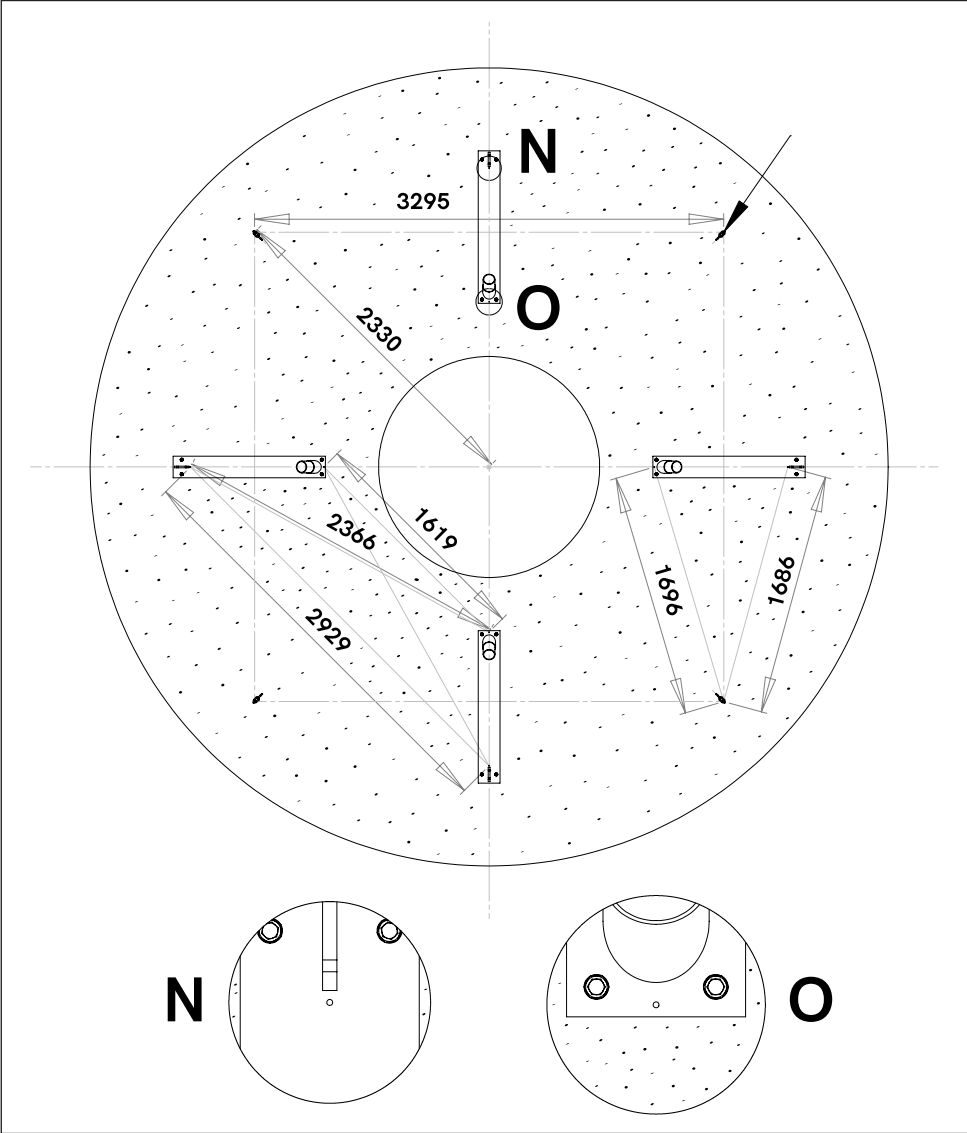
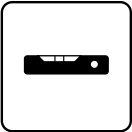
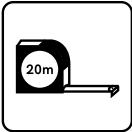

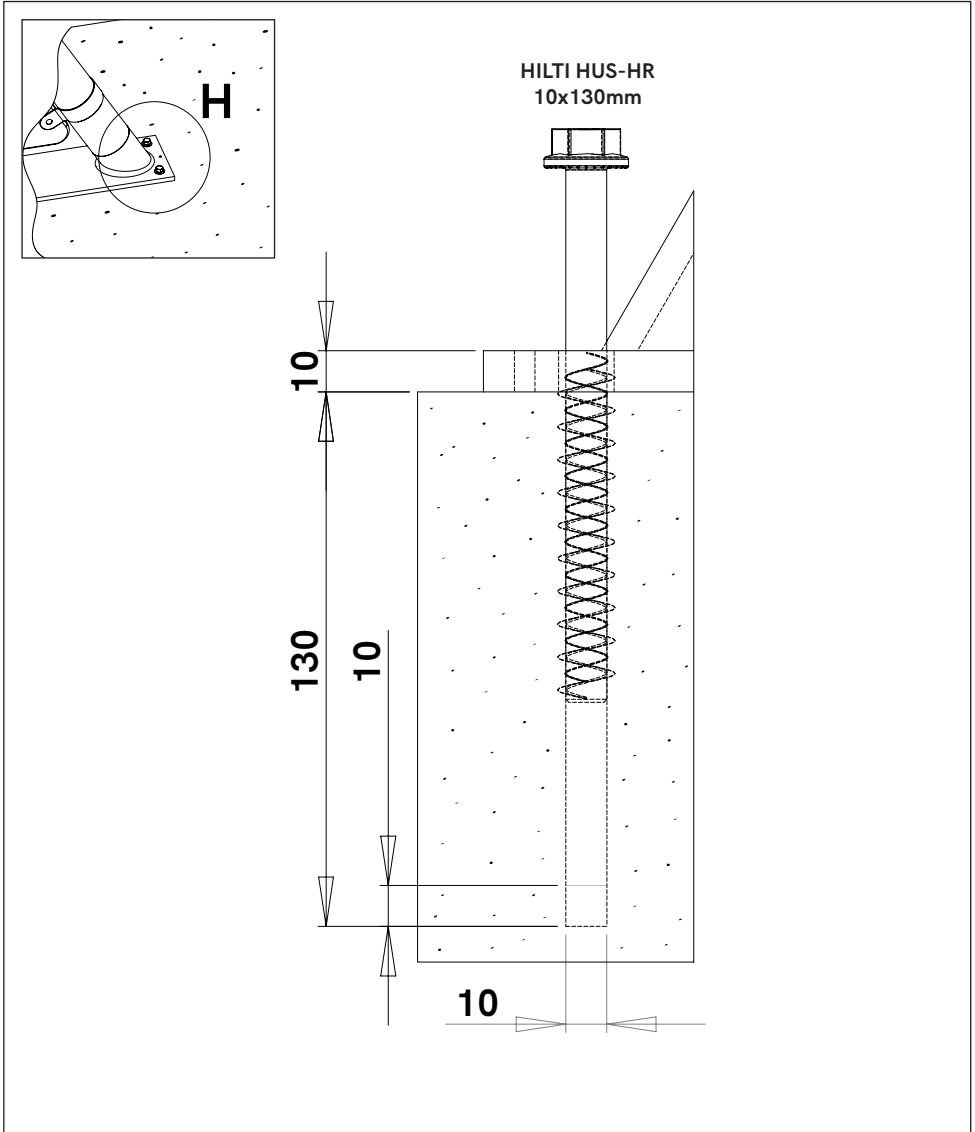
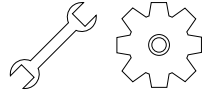

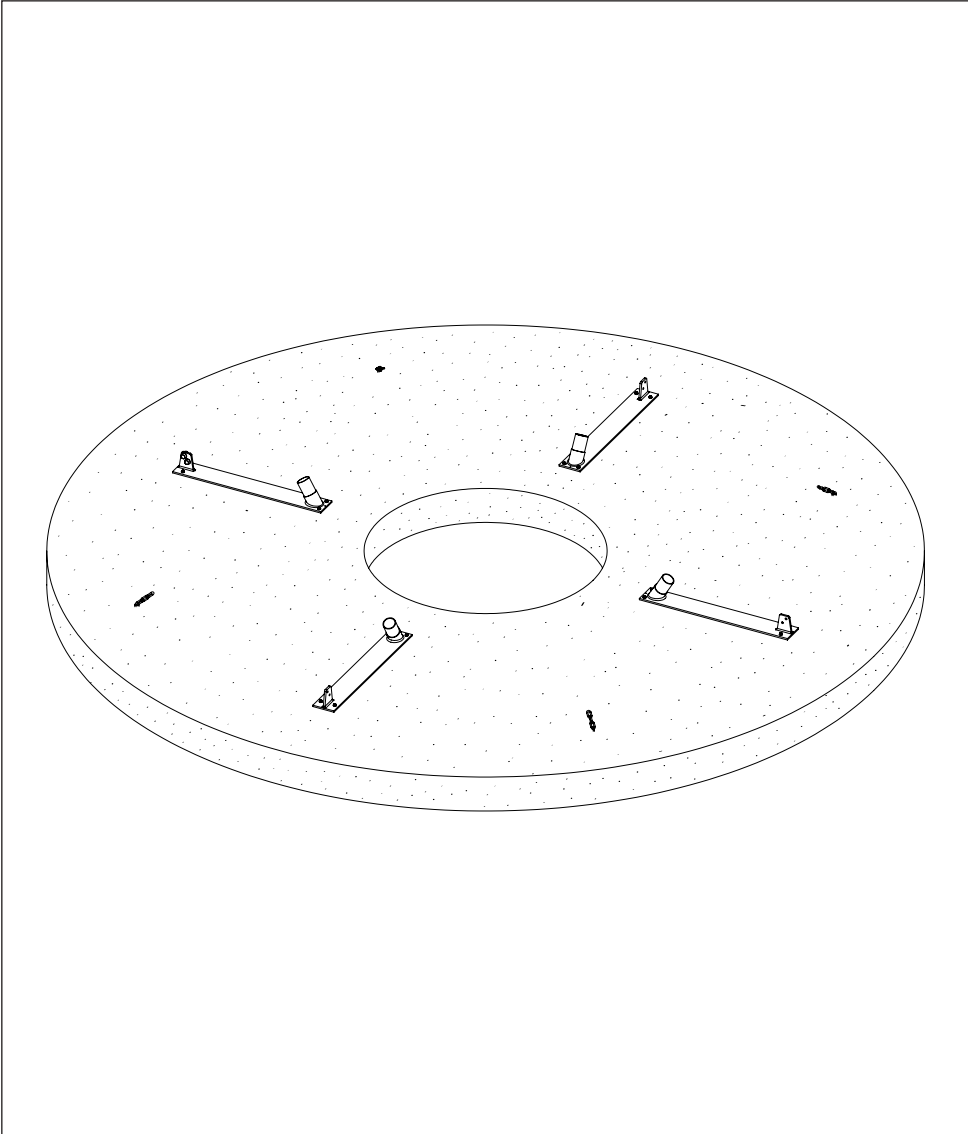
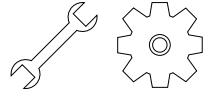

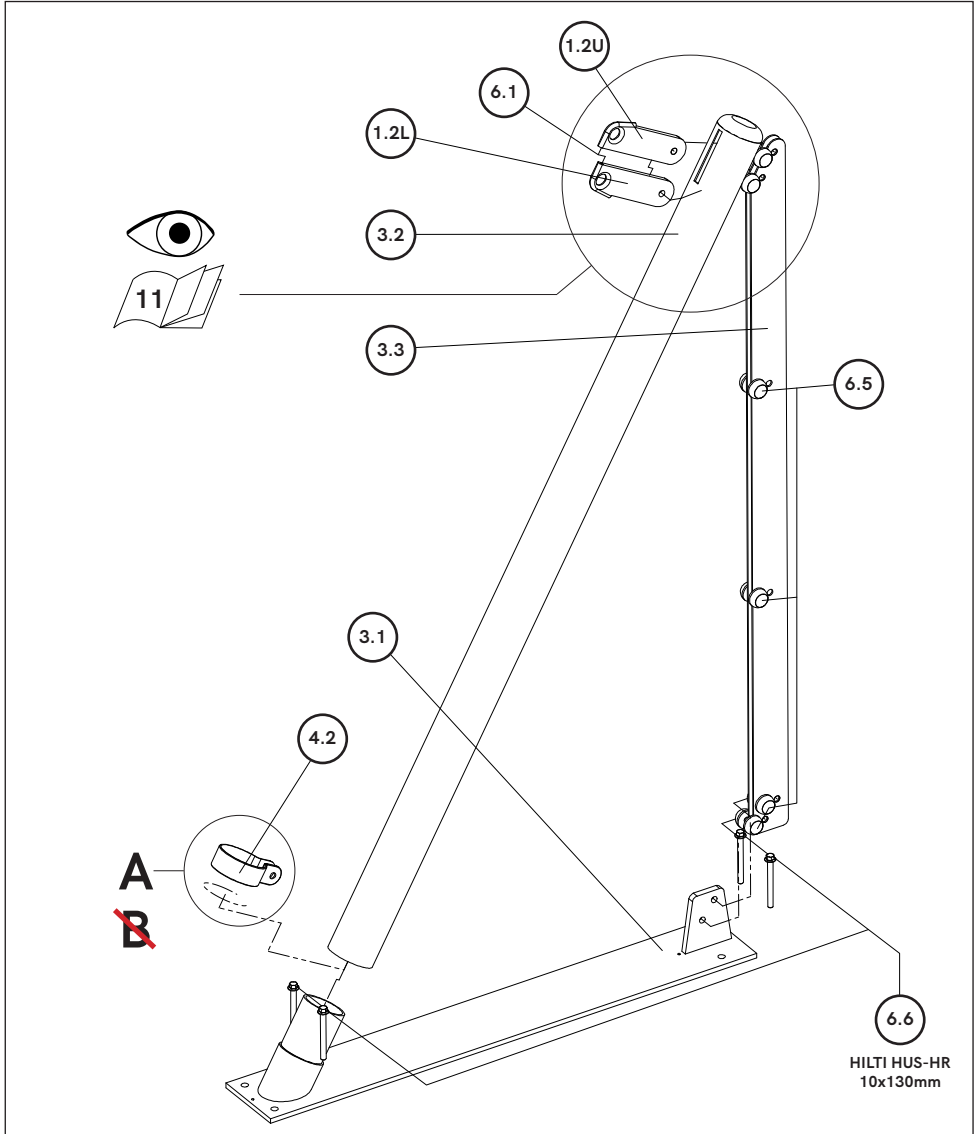
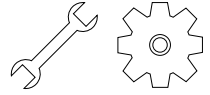

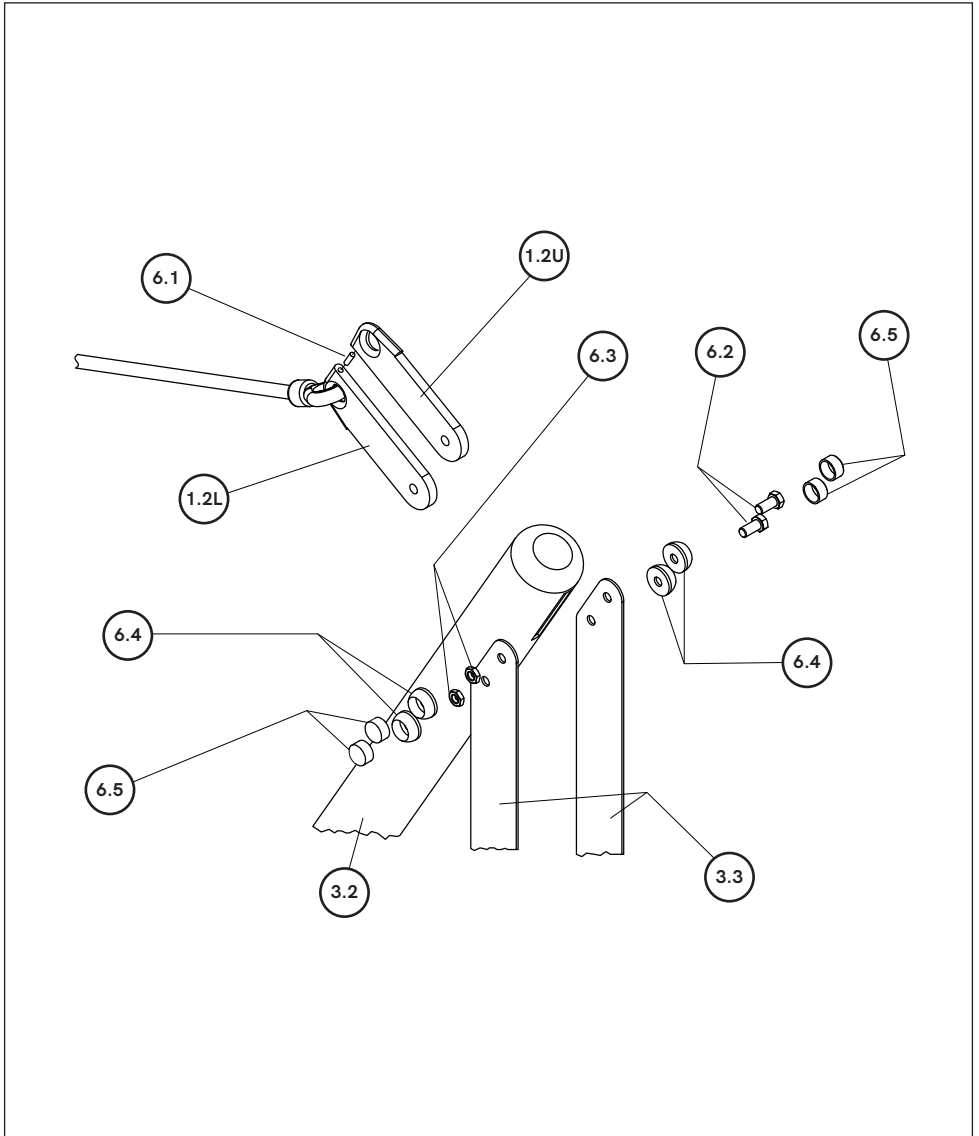
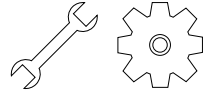

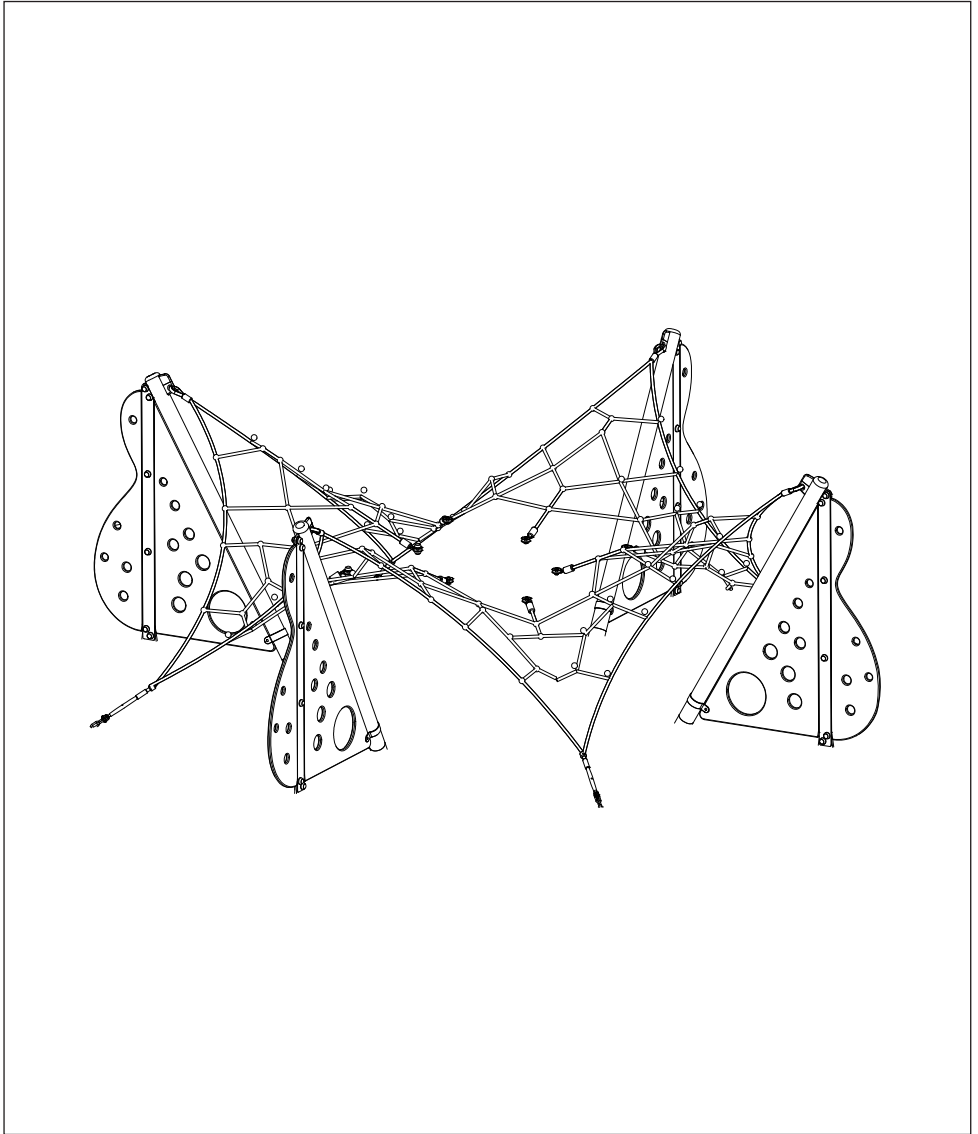
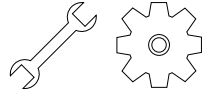

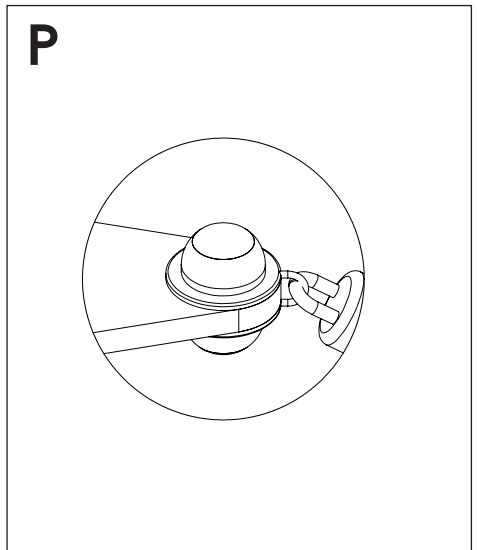
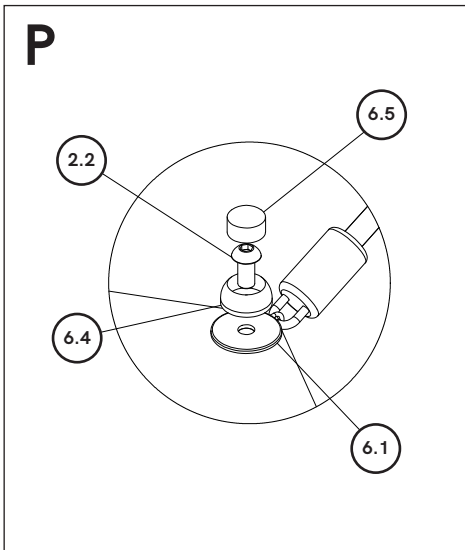
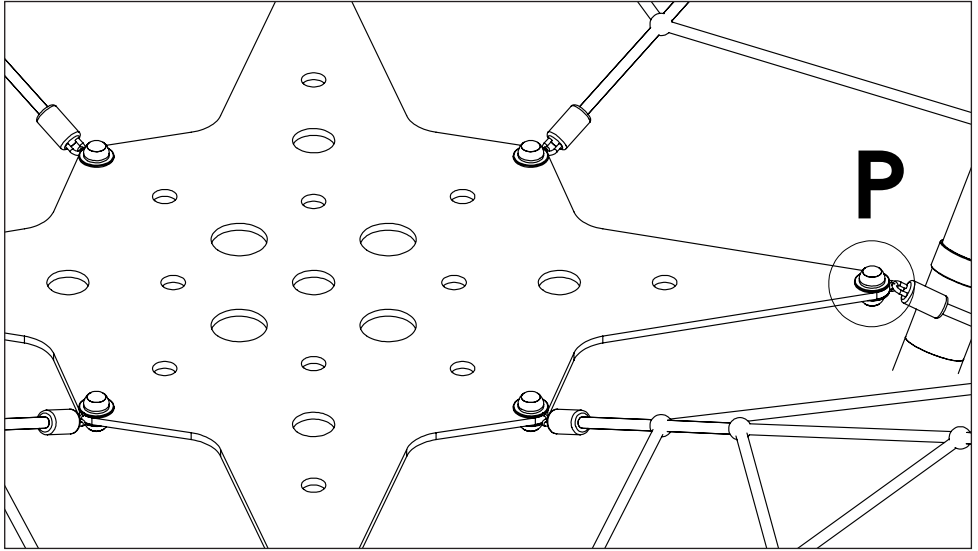

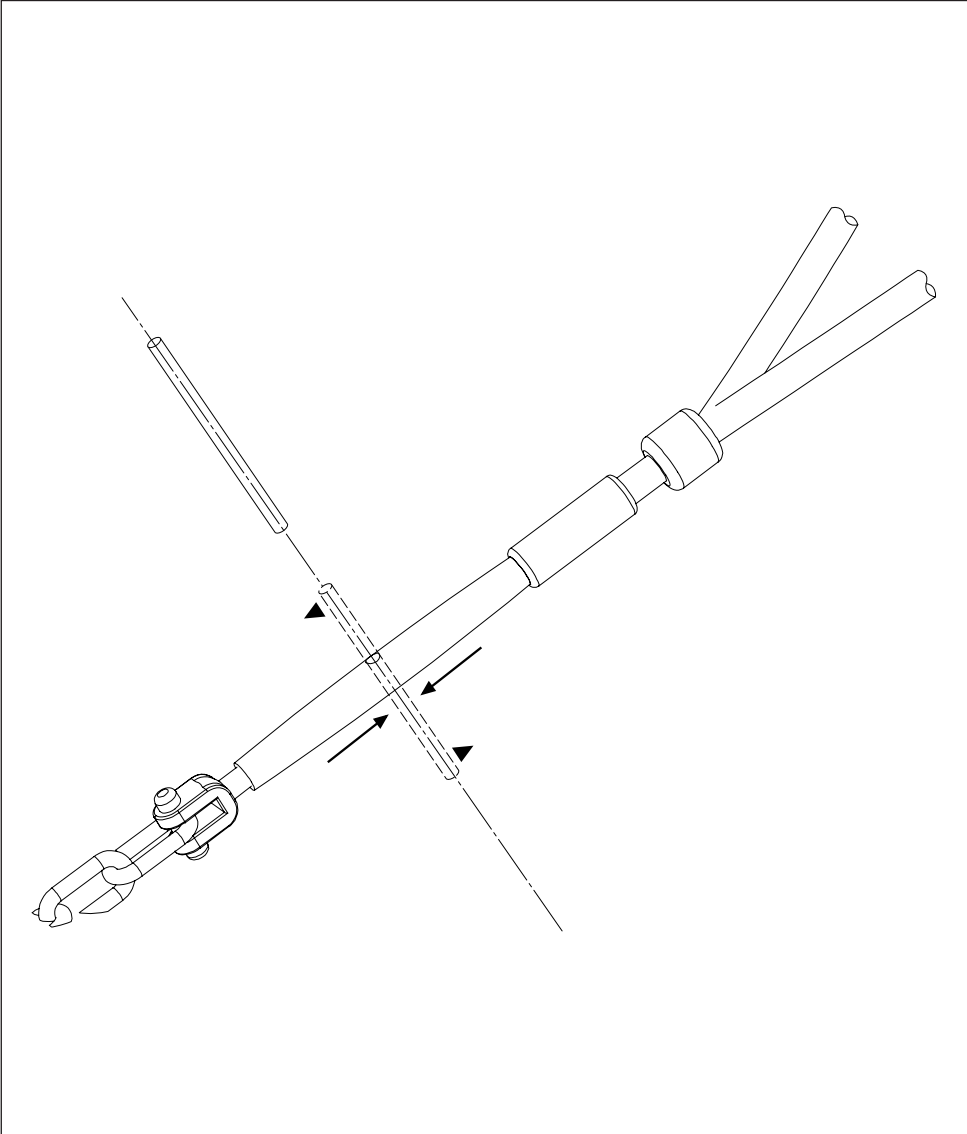

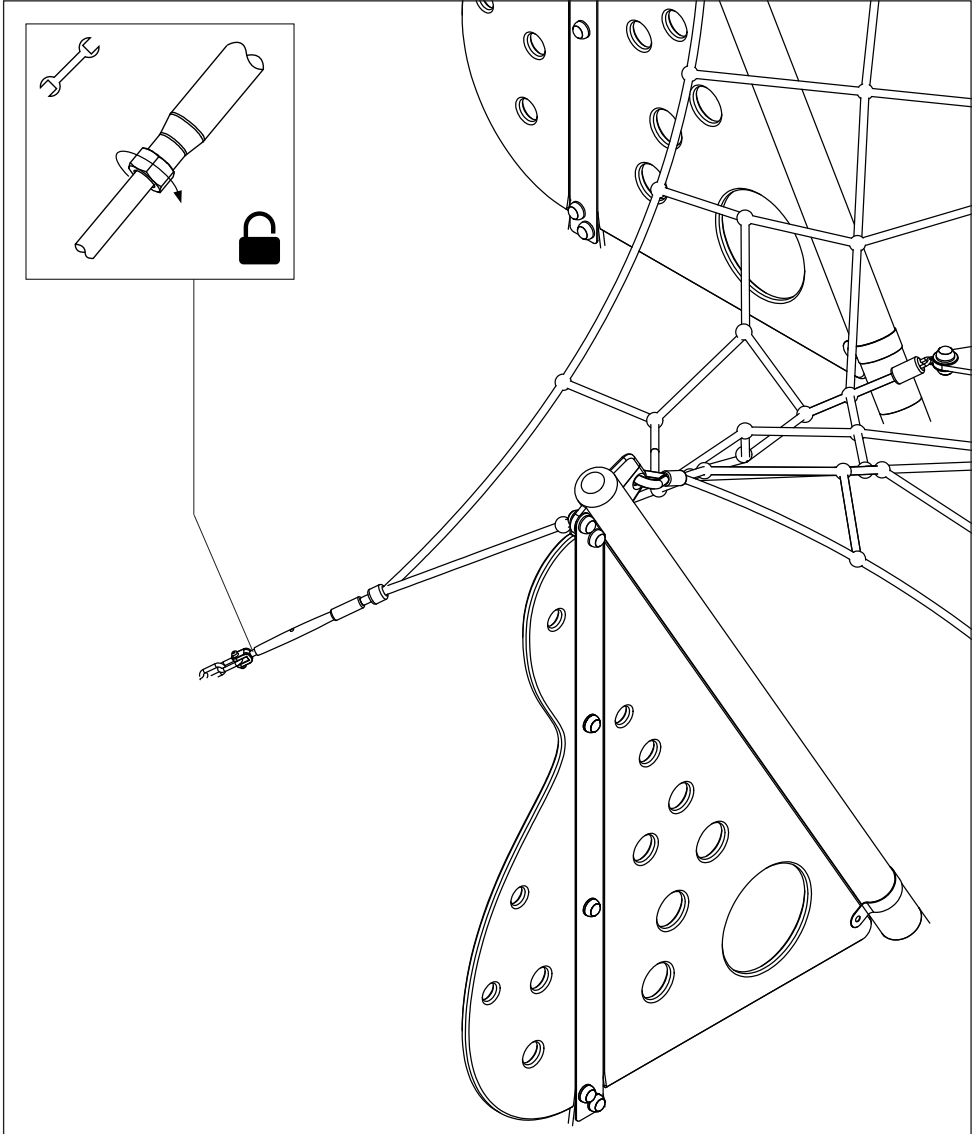
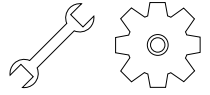

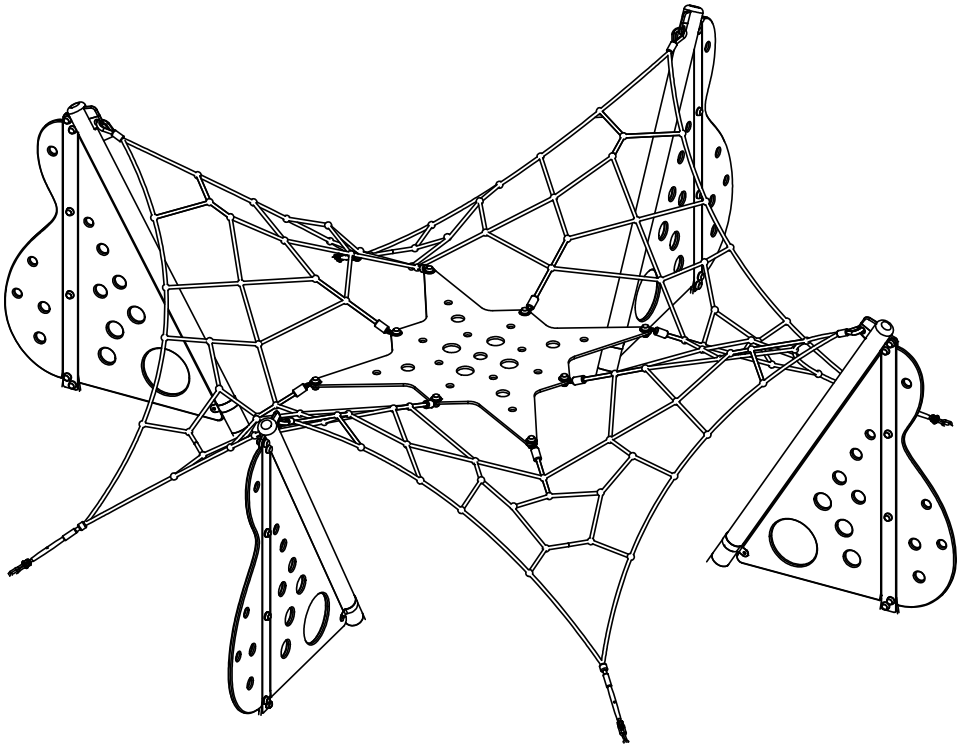



Tayplay Ltd

13A Riverview Business Park
Friarton Road
Perth
PH2 8DF
Scotland

Tel: +44 (0) 1738 449 084
Fax: +44 (0) 1738 449 094
Email: info@tayplay.com
Web: www.tayplay.com

